



# Glooko<sup>®</sup> Uploader

Instructions for use – for Glooko users



# Contents

<b>Find your device .....</b>	<b>4-5</b>
<b>General information .....</b>	<b>6</b>
Product description.....	6
Intended use.....	6
Supported devices.....	6
Warnings.....	6
Contraindications .....	6
<b>Instructions for use .....</b>	<b>7</b>
Patients .....	8
Sign into your MyGlooko dashboard at <a href="https://my.glooko.com">https://my.glooko.com</a> .....	8
Download the software installation file .....	8
Locate the installation file and run the file.....	8
Healthcare providers.....	9
Request a link to download the Glooko Uploader software.....	9
Download the software installation file .....	9
Locate the installation file and run the file.....	9
Patients and healthcare providers .....	10
Open the Glooko Uploader software.....	10
Sign into your Glooko account.....	10
Features in Glooko Uploader .....	11
Upload diabetes data .....	12
View diabetes data.....	13
<b>Compatible devices and transmission methods .....</b>	<b>14</b>

# Find your device



Glucose meter



CGM



Insulin pump

## Abbott

	FreeStyle Freedom Lite.....	14
	FreeStyle InsuLinx.....	14
	FreeStyle Lite.....	14
	FreeStyle Optium Neo.....	14
	FreeStyle Precision Neo.....	14
	Precision Xtra.....	14
	Precision Xceed.....	14

	FreeStyle Libre Reader.....	14
	FreeStyle Libre 2 Reader.....	14
	FreeStyle Libre 3 Reader.....	14

## Acon Laboratories

	On Call® Express.....	14
	On Call® Express II.....	14
	On Call® Express Voice.....	14
	On Call® Extra.....	14
	On Call® Extra Voice.....	14
	On Call® Sure.....	14
	On Call® Sure Sync.....	14

## Activmed

	GlucoCheck GOLD (TD-4289).....	14
--	--------------------------------	----

## AgaMatrix

	WaveSense Jazz™.....	14
	Ally BGK.....	14
	Ally GGM.....	14

## Animas

	OneTouch Ping (meter).....	14
--	----------------------------	----

## Animas

	OneTouch Ping (pump).....	20
	Vibe.....	20

## Arkray

	GlucoCard Shine Connex.....	15
	GlucoCard Shine Express.....	15
	GlucoCard Shine XL.....	15

## Ascensia (Bayer)

	Breeze 2.....	15
	Contour.....	15
	Contour Care.....	15
	Contour Fit.....	15
	Contour Link.....	15
	Contour Next.....	15
	Contour Next (Bluetooth).....	15
	Contour Next Gen.....	15
	Contour Next One.....	15
	Contour Plus.....	15
	Contour Plus Blue.....	15
	Contour Plus Elite.....	15
	Contour Plus One.....	15
	Contour next EZ.....	15
	Contour next Link.....	15
	Contour next Link 2.4.....	15
	Contour next USB.....	15
	Contour TS.....	15
	Contour XT.....	15
	Contour USB.....	15

## Beurer

	GL 44.....	15
	GL 48.....	15
	GL 49.....	15
	GL 60.....	15

## Bionime

	Rightest GM700SB.....	15
--	-----------------------	----

## Biosys

	Aria.....	15
--	-----------	----

## Dexcom

	G4 Platinum.....	19
	G4 Platinum with Share.....	19
	G5.....	19
	Touchscreen Receiver (G5/G6).....	19
	G6 Receiver.....	19
	G7 Receiver.....	19
	One Receiver.....	19
	One+ Receiver.....	19

## Diatesse

	XPER (TD-4289B).....	15
--	----------------------	----

## Ekoweb

	GlucoX (TD-4183).....	16
	GlucoX Pro (TD-4183).....	16

## Embrace

	TALK.....	16
--	-----------	----

## Exacta

	Glance.....	16
--	-------------	----

## Equil/Wellion

	MICRO-pump.....	21
--	-----------------	----

## ForaCare

	Diamond PRIMA.....	16
--	--------------------	----

## GlucRx

	Nexus.....	16
	Nexus Mini.....	16
	Q.....	16

## GlucoSmart

	Salsa.....	16
	Salsa Connect.....	16

## GlucoX

	TD-4183.....	16
--	--------------	----

## iCare

	PalmDoc II.....	16
--	-----------------	----











## i-SENS

	alphacheck professional.....	16
	CareSens BGM/TEE2.....	16
	CareSens Dual.....	16
	CareSens H Beat.....	16
	CareSens N.....	16
	CareSens N Feliz.....	16
	CareSens N POP.....	16
	CareSens N Premier.....	16
	CareSens N Premier Carelight.....	16
	CareSens N Voice.....	16
	Caresens Pro.....	16
	CareSens S Fit.....	16
	No Coding Plus.....	16
	TEE2+.....	16

<b>Infopia</b>	
 Finetest Lite .....	16

<b>Insulet</b>	
 Omnipod® .....	21
 Omnipod® Dash™ System .....	21

<b>Intuity</b>	
 POGO® Automatic™ .....	17

<b>LifeScan</b>	
 OneTouch Select Plus .....	17
 OneTouch Ultra .....	17
 OneTouch Ultra Plus Reflect .....	17
 OneTouch Ultra2 .....	17
 OneTouch UltraEasy .....	17
 OneTouch UltraMini .....	17
 OneTouch Verio .....	17
 OneTouch Verio Flex .....	17
 OneTouch Verio IQ .....	17
 OneTouch Verio Reflect .....	17
 OneTouch Verio Sync .....	17

<b>Medtronic</b>	
 630G .....	21
 640G .....	21
 670G .....	21















<b>Menarini</b>	
 GlucoFix Tech .....	17
 GlucoMen areo .....	17
 GlucoMen areo 2K .....	17
 GlucoMen LX2 .....	17

<b>Nipro</b>	
 4SURE Smart .....	17
 4SURE Smart Duo .....	17

<b>Palmdoc</b>	
 1 .....	17
 Smart .....	17









<b>Prodigy</b>	
 AutoCode .....	17

<b>ReliOn</b>	
 Platinum .....	18
 Premier Blu .....	18
 Premier Classic .....	18
 Premier Voice .....	18



<b>Roche</b>	
 Accu-Chek Active .....	17
 Accu-Chek Aviva Connect .....	17
 Accu-Chek Aviva Combo .....	19
 Accu-Chek Aviva Expert .....	19
 Accu-Chek Aviva Nano .....	19
 Accu-Chek Aviva Plus Black .....	19
 Accu-Chek Aviva Plus Silver .....	19
 Accu-Chek Compact Plus .....	19
 Accu-Chek Guide .....	17
 Accu-Chek Guide Me .....	17
 Accu-Chek Instant .....	17
 Accu-Chek Mobile (USB) .....	17
 Accu-Chek Nano .....	19
 Accu-Chek Performa .....	19
 Accu-Chek Performa Nano .....	19

<b>Roche</b>	
 Accu-Chek Aviva Insight .....	22
 Accu-Chek Performa Insight .....	22
 Accu-Chek Aviva Solo .....	21
 Accu-Chek Guide Solo .....	21
 Accu-Chek Spirit Combo .....	22

<b>Sanofi</b>	
 BGStar .....	18

<b>Taidoc</b>	
 TD-4141 .....	18
 TD-4183 .....	18
 TD-4255 .....	18
 TD-4257(v1) .....	18
 TD-4257(v2) .....	18
 TD-4280 .....	18
 TD-4285 .....	18
 TD-4289 .....	18

<b>Tandem</b>	
 t:flex .....	21
 t:slim .....	21
 t:slim G4 .....	21
 t:slim X2 .....	21

<b>Terumo</b>	
 Medisafe Fit Smile .....	20
 Medisafe WITH .....	20

<b>ViCentra</b>	
 Kaleido .....	21

<b>Trividia (Nipro)</b>	
 TRUE METRIX .....	17
 TRUE METRIX AIR .....	17
 TRUResult .....	17
 TRUEyou mini .....	17

<b>Wellion</b>	
 Calla Mini .....	18
 Galileo Compact .....	18
 Leonardo Compact .....	18

<b>XPER Technology</b>	
 A1 (TD-4183) .....	18

<b>Ypsomed</b>	
 Mylife Aveo .....	18

# General information

## Product description

Glooko Uploader® is indicated for use by individuals or healthcare professionals in the home or healthcare facilities to transfer predefined data from home monitoring devices to a server database. The device can be used as a stand-alone product or in combination with the Glooko System.

## Intended use

The Glooko system is a diabetes management platform that can be used in-clinic or remotely by Health Care Professionals and patients. It allows viewing of patient data from compatible medical devices and other health monitoring devices. It also allows Health Care Professionals to support the treatment of diabetes through analysis and monitoring of a patient's diabetes therapy and Care Programme.

## Supported devices

To get started, individuals will need:

1. A compatible blood glucose meter, insulin pump or continuous glucose monitor (CGM);
2. A PC or Mac computer with one of the following operating systems (OS):
  - Windows 10 (32-bit and 64-bit)
  - Windows 11 (32-bit and 64-bit)
  - macOS 14.0: Sonoma
  - macOS 15.0: Sequoia
  - macOS 26.0: Tahoe
3. the Glooko Uploader software;
4. A Glooko account; and
5. The syncing or device download cable supplied with the supported diabetes device.

## Warning!

Glooko does not measure, interpret, or make decisions on the data it conveys nor is it intended to provide automated treatment decisions or be used as a substitute for professional judgment. All medical diagnosis and treatment are to be performed under the supervision and oversight of an appropriate healthcare provider.

If you have concerns about your current diabetes diagnosis and treatment, please contact your healthcare provider.

In the event where the Glooko System is malfunctioning, please discontinue use of the product and contact Glooko Support.

## Contraindications

None.

# Instructions for use – Glooko Uploader

You will need to create a Glooko account to use Glooko Uploader. The data uploaded using Glooko Uploader will synchronise to your Glooko account, which can be accessed using your Glooko login information. Internet (WiFi or mobile data network) access is necessary for your data to synchronise to the Glooko server.

## Patients:

- Learn how to install and upload data using Glooko Uploader on the next page.

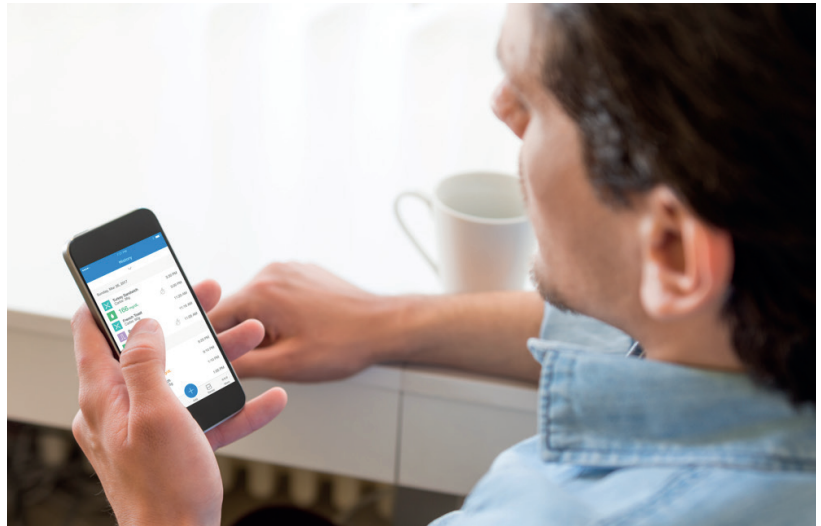

---

## Healthcare providers:

- Learn how to install and upload data using the Glooko Uploader on page 9.



# Patients

In order to access the MyGlooko dashboard and download the Glooko Uploader software, you will need to have a Glooko account. You can sign up for Glooko using the Glooko mobile app for iOS or Android. You can also contact **Glooko Support** (<https://support.glooko.com>) for assistance in creating an account. Once you have created a Glooko account, please follow the instructions below.

## 1 Sign into your MyGlooko dashboard at <https://my.glooko.com>

- Enter your email address and password.
- Tap Sign In.

### GET HELP SIGNING INTO YOUR GLOOKO ACCOUNT

- **FORGOT PASSWORD:**  
If you are unable to remember your password to sign in, tap **Forgot Password** to receive a password reset email. Follow the instructions on the screen. You can also contact Glooko Support for assistance.
- **UNLOCK YOUR ACCOUNT:**  
If you enter your password incorrectly five times, your account will be locked. An email with unlock instructions will automatically be sent to the email address registered to your account. However, if you do not receive an email, click **Didn't receive unlock instructions** – you will be redirected to the Unlock page. Follow the instructions on the screen. You can also contact Glooko Support for assistance.

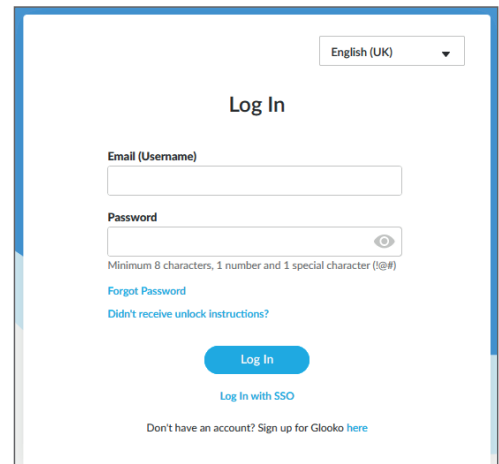

## 2 Download the software installation file

After logging into your MyGlooko dashboard, you will need to download the installation file.

- Tap **Settings**.
- Scroll to the bottom of the page and click **Get Glooko Uploader**.
- You will be taken to a screen with buttons to install Glooko Uploader on a Mac or PC. Click either the Mac or PC button to download the installation file.



## 3 Locate the installation file and run the file

Depending on your web browser and operating system, you may need to search for the downloaded installation file or you may see a popup window asking you to run the file.

- If you are using a **PC**, look in your recent downloads folder
- If you are using a **Mac**, look in the downloads folder in Finder

Once you have located the file, double-click on it and follow the installation instructions on the screen. You will need to restart your computer at the end of the installation process.

**NOTE:** For FreeStyle Libre users in Sweden, Norway and the US, it's important to select that you are using a FreeStyle Libre during the installation process. This will install the additional FreeStyle Libre DataHub required for these uploads.

# Healthcare providers

In order to use the Glooko Uploader software, you will need a Glooko provider account and a subscription that supports Glooko Uploader. You will also need a specific link to download Glooko Uploader. Please contact Glooko Support (<https://support.glooko.com>) for assistance.

## 1 Request a link to download the Glooko Uploader software

Healthcare providers must request a link to download the Glooko Uploader software.

- Please contact Glooko Support (<https://support.glooko.com>) to request a link to download the Glooko Uploader software.

## 2 Download the software installation file

- When you receive the link to download the software from Glooko, click the link in your email. You will be taken to a screen with buttons to install Glooko Uploader on a Mac or PC. Click either the Mac or PC button to download the installation file.



## 3 Locate the installation file and run the file

Depending on your web browser and operating system, you may need to search for the downloaded installation file or you may see a popup window asking you to run the file.

- If you are using a **PC**, look in your recent downloads folder
- If you are using a **Mac**, look in the downloads folder in Finder

Once you have located the file, double-click on it and follow the installation instructions on the screen. You will need to restart your computer at the end of the installation process.

**NOTE:** For FreeStyle Libre users in Sweden, Norway and the US, it's important to select that you are using a FreeStyle Libre during the installation process. This will install the additional FreeStyle Libre DataHub required for these uploads.

# Patients and healthcare providers

After installing Glooko Uploader and restarting your computer, locate the Glooko Uploader icon on either your desktop (PC) or in your Applications folder (Mac).

## 4 Open the Glooko Uploader software

- **Locate** the Glooko Uploader icon on your desktop (PC) or in your Applications folder (Mac).
- **Double-click** on the Glooko Uploader icon to start the program.

**NOTE:** Make sure you have restarted your computer before starting Glooko Uploader for the first time.



## 5 Sign into your Glooko account

Once the Glooko Uploader program opens, you will need to sign into your Glooko account.

- Enter your **email or username**
- Enter your **password**
- Tap **Sign In**.

### GET HELP SIGNING INTO YOUR GLOOKO ACCOUNT

If you cannot remember your password to sign in, click **Forgot Password** to receive a password reset email. You can also contact Glooko Support for assistance.

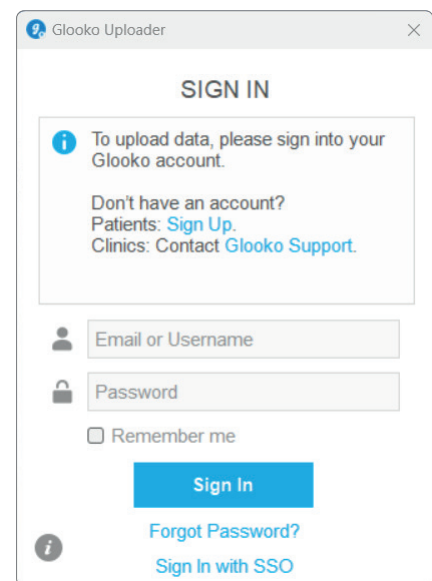

### SINGLE SIGN-ON (SSO) FOR HEALTH CARE PROVIDERS (HCPS)

The single sign-on (SSO) feature allows Health Care Professionals to log in using their clinic's existing secure authentication service (identity provider (IdP)).

1. Click the "Sign in with SSO" option at the bottom of the sign-in window.
2. You will be directed to Glooko Web, where you need to enter the email address associated with your Glooko account.
3. Glooko will communicate with your clinic's configured system to identify your IdP and you will be redirected to your IdP's login page.
4. Log in using your usual clinic credentials for that identity provider.
5. Once authenticated by your clinic's system, you will be directed back to the Glooko Uploader screen to proceed with device data upload.

# Patients and healthcare providers

## 6 Features in Glooko Uploader

### LOG OUT OF YOUR ACCOUNT

- You can log out of your Glooko account by tapping the Profile button  in the bottom right-hand corner of Glooko Uploader.
- Tap **Log out**

### VIEW YOUR PROFILE INFORMATION

- You can view your profile information by tapping the Profile button  in the bottom right-hand corner of Glooko Uploader.
- This popup includes:
  - o Your **name**
  - o Your **primary authorised site** (healthcare provider) and the associated **ProConnect code**
  - o Your **email address**
- Tap **Log Out**.

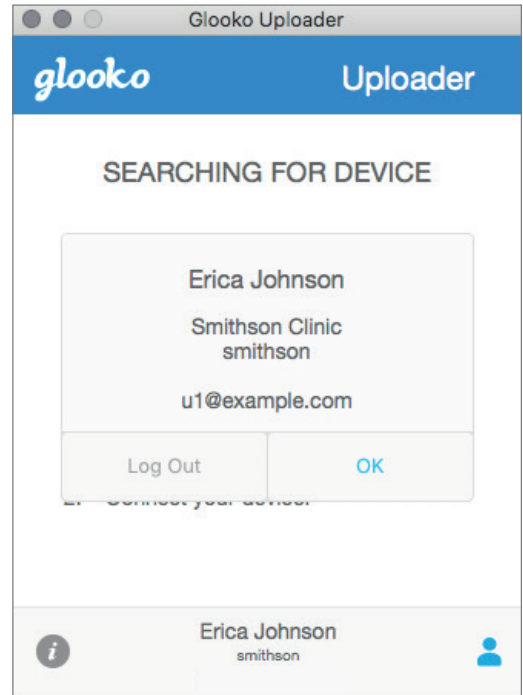

### SEE ADDITIONAL INFORMATION ABOUT GLOOKO UPLOADER

- You can view additional information by tapping the Info button  in the bottom left-hand corner of Glooko Uploader.
- This popup includes product support information, product description, and the intended use statement.

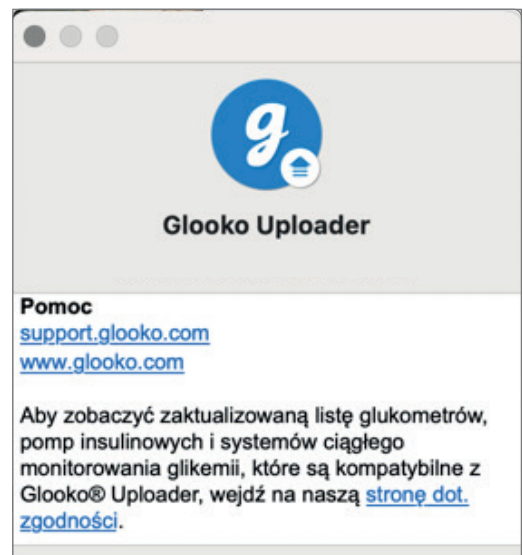

# Patients and healthcare providers

## 7 Upload diabetes data

Once you have signed into Glooko Uploader, you can upload your diabetes device data.

### CONNECT THE CABLE FOR YOUR DIABETES DEVICE TO THE COMPUTER

After logging in, Glooko Uploader will start searching for a device.

- Connect the appropriate USB cable or infrared (IR) cable for the diabetes device to the computer.
- Once the cable is recognised, wait a few seconds for the cable drivers to be recognised before connecting your device.

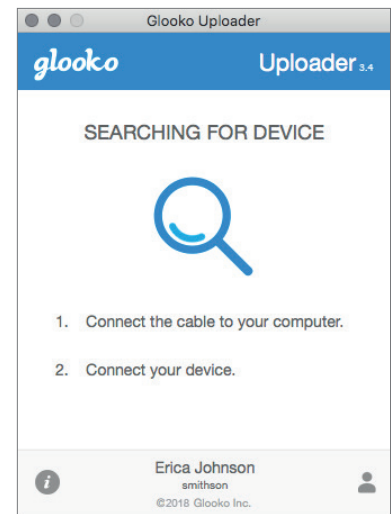

### CONNECT THE DIABETES DEVICE TO THE CABLE

- After connecting the cable to the computer, connect the diabetes device to the cable.

**NOTE:** Make sure you use the cable supplied with your diabetes device. If you need a new cable, please contact the manufacturer of your diabetes device.

- After connecting the diabetes device to your computer using the cable supplied with the device, your device will begin uploading data using Glooko Uploader.
- If an error occurs, please follow the instructions on the screen to resolve the error. If you continue to experience difficulties, please contact Glooko Support for assistance.

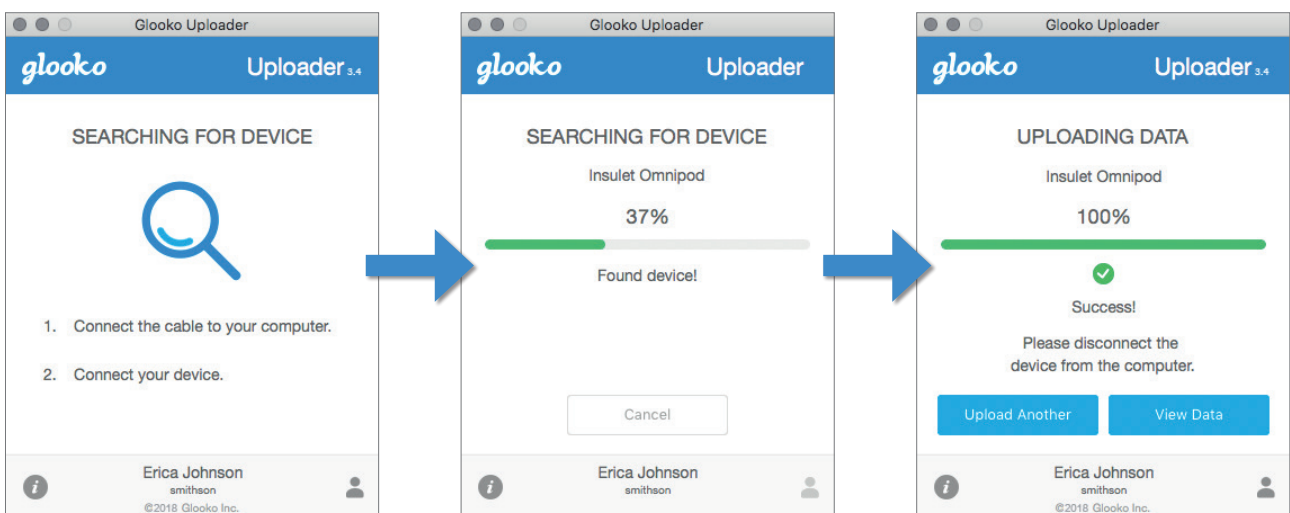

# Patients and healthcare providers

## 8 View diabetes data

After uploading your diabetes device data using Glooko Uploader, you can view the data at <https://my.glooko.com> by logging into your Glooko account.

- **Patients:**  
To learn more about the MyGlooko web dashboard, please refer to [Glooko for personal use – Quick start guide](#) at <https://support.glooko.com>
- **Healthcare providers:**  
To learn more about Population Tracker, please refer to: [Glooko for clinics – Quick start guide](#) at <https://support.glooko.com>



# Compatible devices and transmission methods

Below are instructions on how to upload diabetes data to Glooko using Glooko® Uploader. Unless explicit upload instructions are provided for the device, it will upload automatically when you connect it to the PC/Mac using its specific USB cable.

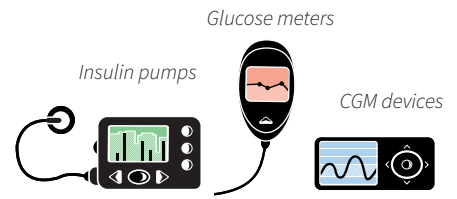

*i* Please note that some of the diabetes devices may not be available in your market.

## Blood glucose meters – connected via USB cable

### Abbott

FreeStyle Freedom Lite | FreeStyle Lite

Abbott FreeStyle USB  
(2,5 mm)



FreeStyle InsuLinx | FreeStyle Optium Neo  
FreeStyle Precision Neo

Micro USB



Precision Xceed | Precision Xtra

Abbott Xceeds  
USB



FreeStyle Libre Reader | FreeStyle Libre 3 Reader  
FreeStyle Libre 2 Reader

Micro USB



Compatibility is limited to Sweden, Norway, and the US by Abbott.

**NOTE:** During the installation process of the Glooko Uploader software, make sure that you select that you're using a FreeStyle Libre. This will install the additional FreeStyle Libre DataHub required for these uploads.

### Acon Laboratories

On Call® Express | On Call® Extra Voice  
On Call® Express II | On Call® Sure  
On Call® Express Voice | On Call® Sure Sync  
On Call® Extra

On Call USB  
(2,5 mm)



### Activmed

GlucoCheck GOLD (TD-4289)

Micro USB



### Agamatrix

WaveSense Jazz

Agamatrix USB



Ally BGK

Micro USB



Ally BGM

i-Sens USB  
(2,5 mm)



### Animas

OneTouch Ping (meter)

Mini USB



1. Connect to your computer.
2. Press the power button on the meter.

# Blood glucose meters – connected via USB cable

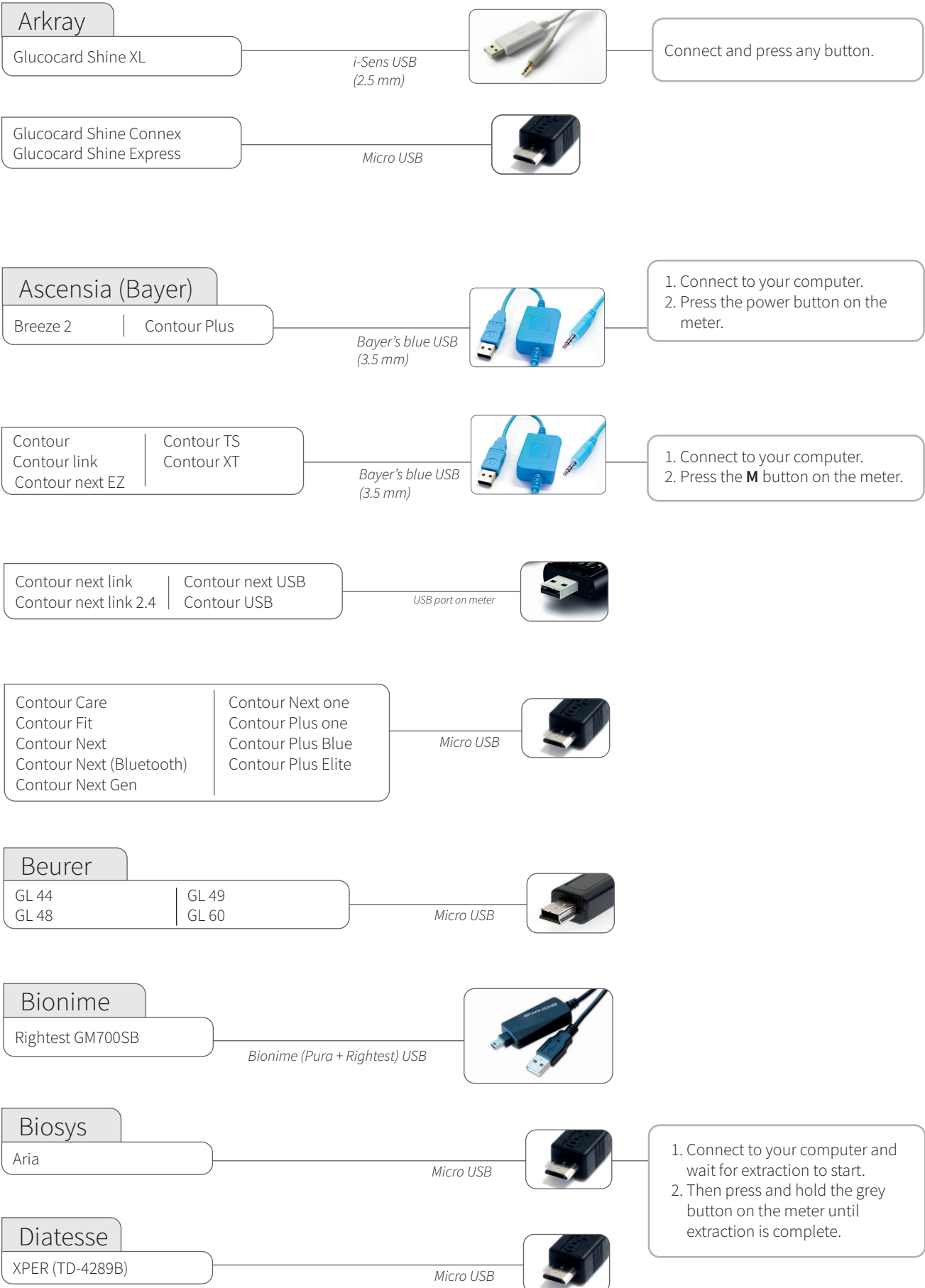

# Blood glucose meters – connected via USB cable

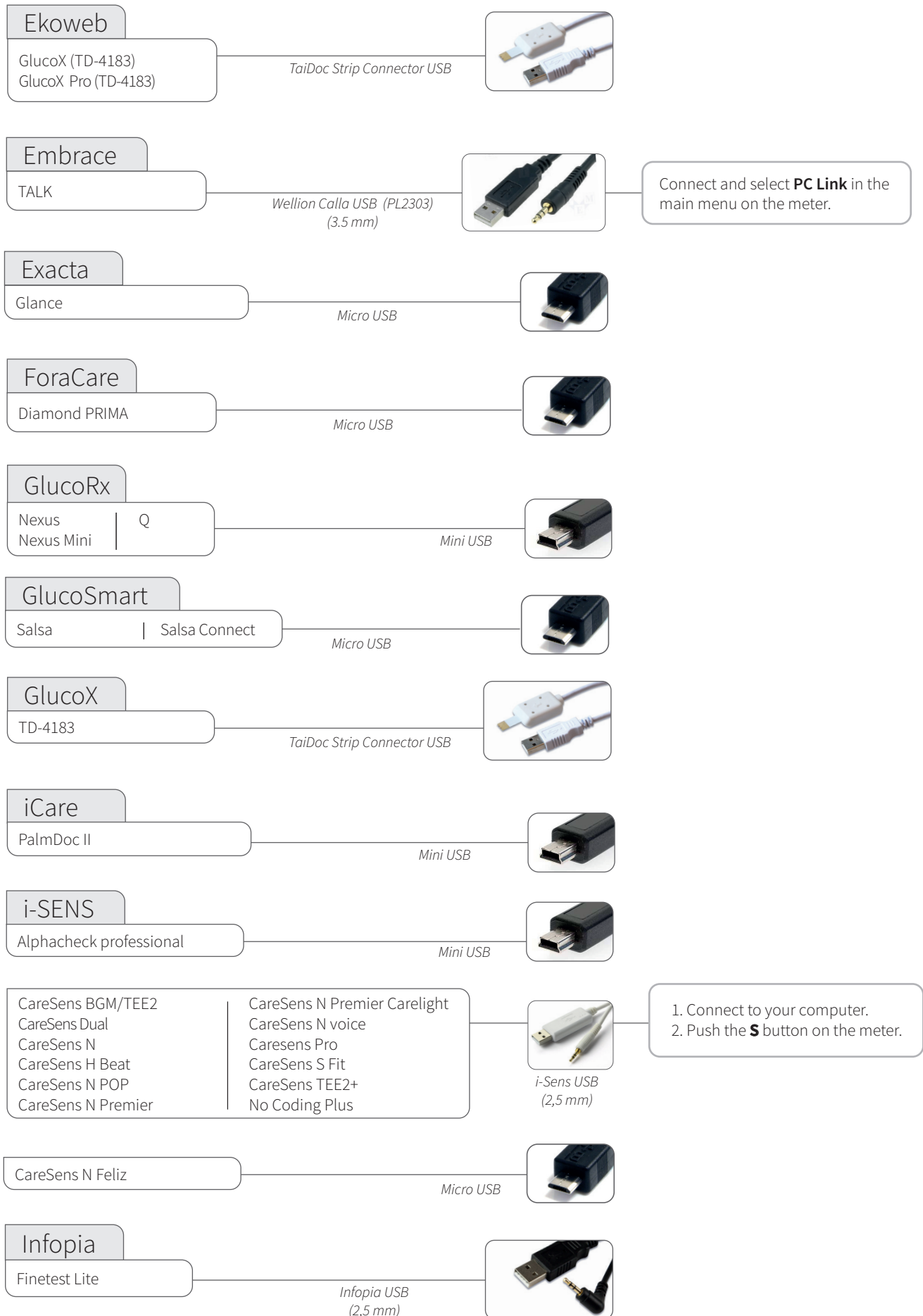

# Blood glucose meters – connected via USB cable

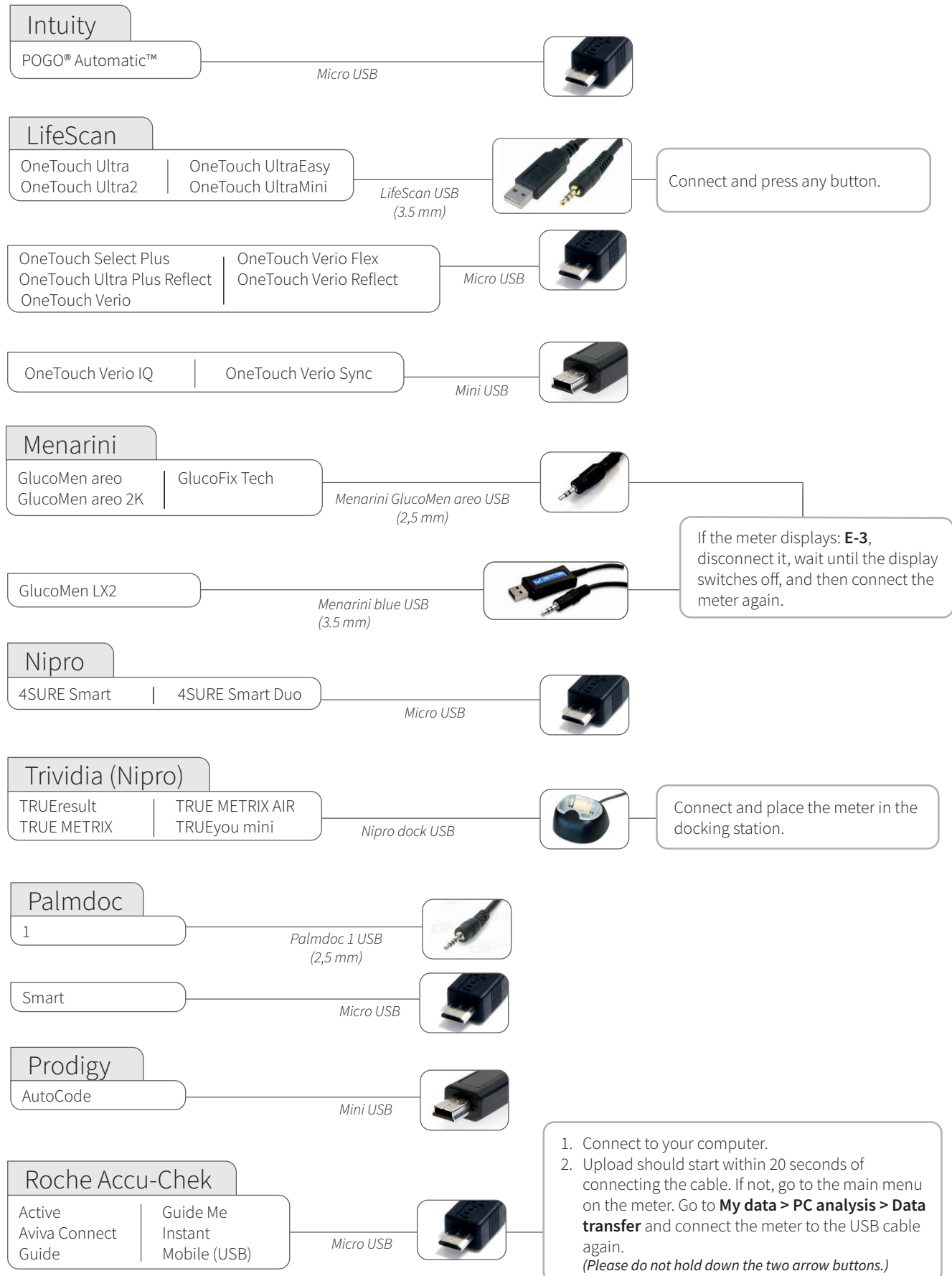

# Blood glucose meters – connected via USB cable

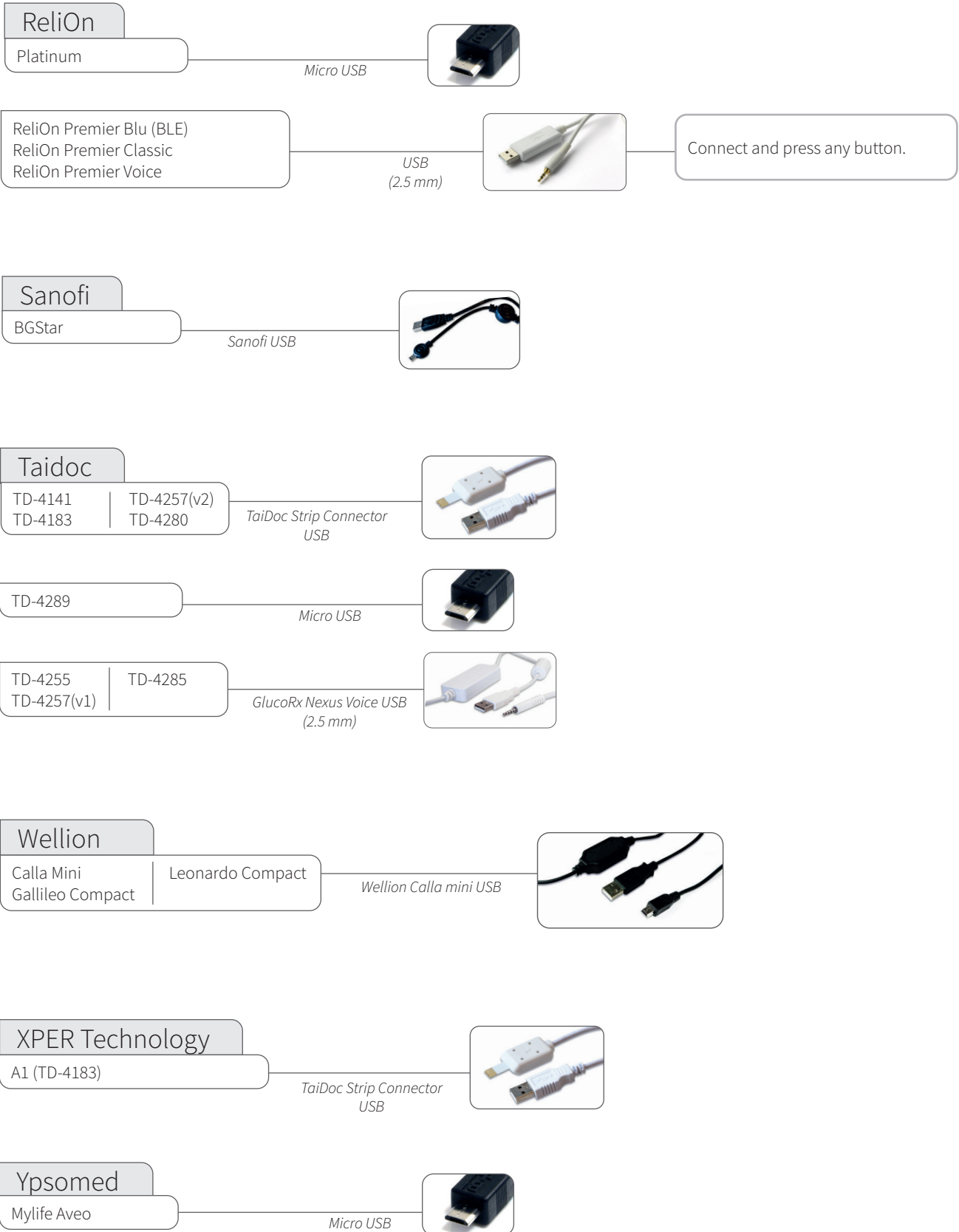

## Blood glucose meters – with infrared connection



### Roche (IR)

Accu-Chek Aviva Nano  
Accu-Chek Aviva Plus Black  
Accu-Chek Aviva Plus Silver  
Accu-Chek Nano  
Accu-Chek Performa  
Accu-Chek Perfoma Nano



ACTISYS Li, Li2 or Accu-Chek 360°

1. Connect the IR cable to your computer.
2. With the meter off, activate IR transmission by pushing and holding the two arrow buttons until two arrows appear in the display.

Accu-Chek Compact Plus



ACTISYS Li, Li2 or Accu-Chek 360°

1. Connect the IR cable to your computer.
2. Activate IR transmission by pushing and holding the **S** and **M** buttons below the display until two arrows appear in the display.

Accu-Chek Aviva Combo  
Accu-Chek Aviva Expert



ACTISYS Li, Li2 or Accu-Chek 360°

1. Connect the IR cable to your computer.
2. In the main menu, go to **My data** and select **Data transfer**.

## CGMs – connected via USB cable

### Dexcom

G4 Platinum  
G4 Platinum with Share  
G5  
Touchscreen Receiver (G5/G6)  
G6 Receiver  
G7 Receiver  
One Receiver  
One+ Receiver

Micro USB



If the upload fails to start, disconnect the receiver and select Shutdown in the menu to turn the receiver off. Turn the receiver on again and connect it to the computer.

# Blood glucose meters and Insulin pumps - with NFC connection

Terumo

Medisafe Fit Smile



1. Connect the NFC plate provided by Terumo to your computer.
2. Place the meter on top of the NFC plate.

*Please note that the transmission symbol on the back of the remote control needs to be aligned with the NFC symbol on the NFC Plate.*

Medisafe WITH



1. Connect the NFC plate provided by Terumo to your computer.
2. Make sure the main menu is showing on the remote control for the pump.
3. Place the remote control on top of the NFC plate.

*Please note that the transmission symbol on the back of the remote control needs to be aligned with the NFC symbol on the NFC Plate.*

# Insulin pumps – with infrared connection

Animas (IR)





OneTouch Ping Vibe



1. Suspend the pump. (MAIN MENU, scroll to **Suspd/Resum** and press **OK**; **Suspend** is highlighted).
2. Press **OK**.
3. Place the pump with its back to the Actisys IR wireless download cable.
4. When the transmission is finished: Resume pump (MAIN MENU, scroll to **Suspd/Resum** and press **OK**; **Resume** is highlighted). Press **OK**.

**ACTISYS LI or LI2**  
*Note! If you are using Windows 8 or 10, you need to use the ACTISYS Li2 cable.*

## Compatible infrared cables

<p><b>ACTiSYS – Li cable</b></p>  <p style="text-align: right; font-size: 2em; color: orange;">-Li</p> <p><b>Compatible operating systems:</b>          macOS X: 10.14–12.0          Windows: N/A</p>	<p><b>ACTiSYS – Li2 cable</b></p>  <p style="text-align: right; font-size: 2em; color: orange;">-Li2</p> <p><b>Compatible operating systems:</b>          macOS X: 10.14–12.0          Windows: 8, 10</p>	<p><b>Accu-Chek – 360° cable (Realtyme)</b></p>  <p><b>Compatible operating systems:</b>          macOS X: 10.14–12.0          Windows: 8, 10</p>	<p><b>Roche Accu-Chek Smart Pix 2 cable</b></p>  <p><b>Compatible operating systems:</b>          macOS X: 10.14–12.0          Windows: 8, 10</p>
--	--	---	--

 **Need a cable?**  
 Please contact the manufacturer of your specific diabetes device.

# Insulin pumps – connected via USB cable

Equil/Wellion  
MICRO-pump

Micro USB



Insulet  
Omnipod® System

Mini USB



Omnipod® Dash™ System

Micro USB



1. Connect and press the power button on the PDM.
2. Unlock the PDM and tap 'Export' on the screen.

Medtronic

630G	670G
640G	

USB port on meter

1. Connect a Contour Next Link 2.4 meter to one of your computer's USB ports.
2. Follow the on-screen instructions presented in your Glooko Uploader to upload data from your Medtronic pump.

Roche

Accu-Chek Aviva Solo  
Accu-Chek Guide Solo

Micro USB



1. Open the Main Menu on the pump's hand unit.
2. Select USB in the Main Menu.
3. Connect the hand unit to the computer with the micro USB cable.

Tandem

t:flex	t:slim G4
t:slim	t:slim X2

Micro USB



Vicentra  
Kaleido

Micro USB



Go to the yellow menu and choose data upload.

# Insulin pumps – connected via infrared cables

## Compatible infrared cables

Roche Accu-Chek Smart Pix cable



Roche Accu-Chek Smart Pix 2 cable



Roche  
Accu-Chek Aviva Insight  
Accu-Chek Performa Insight

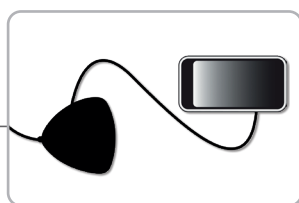

### Smart Pix 2

*Note! Connect the handset of your pump with a micro USB cable to the Smart Pix 2.*

1. Connect the Smart Pix 2 cable to your computer and wait for the blue indicator on Smart Pix 2 to start flashing slowly.
2. Connect the handset to Smart Pix 2 using a micro USB cable.
3. In the handset menu select **Connect to PC** and press **OK**.
4. Ensure that the pump is within range of the handset.
5. The blue indicator on Smart Pix 2 is on while data is being transmitted from the device to Smart Pix 2.
6. The blue indicator turns itself off and both Smart Pix 2 and the device emit a sound to signal that data is being transmitted from Smart Pix 2 to Glooko Uploader. Do not disconnect Smart Pix 2 yet!
7. Wait for Glooko Uploader to confirm the upload was successful.

Roche  
Accu-Chek Spirit Combo



### Smart Pix or Smart Pix 2

*Note! Smart Pix software version 3.02 or higher is required when using Smart Pix.*

1. Connect the Smart Pix to your computer and wait for the blue indicator on the Smart Pix to start flashing slowly.
2. Put the pump in **Data Transfer** mode (stop the pump and enter the **Data Transfer** menu).
3. Place the pump with its IR eye towards the Smart Pix. The blue indicator signals the data is being transmitted to the Smart Pix.
4. Wait for the blue indicator to start flashing slowly again or stop flashing altogether.
5. The data is now being transmitted from the Smart Pix to Uploader. Do not disconnect the Smart Pix yet!
6. Wait for Uploader to signal the upload was successful.



If you have questions, our Support Team is always happy to help.  
You can reach out to us in any of the following ways:

- Web Support: <https://support.glooko.com>
- Email Support: [diabetes@amsl.com.au](mailto:diabetes@amsl.com.au) or [diabetes@nzms.co.nz](mailto:diabetes@nzms.co.nz)  
(Our distributor in Australia and New Zealand)
- Tel. Support: [+61 1300 851 056](tel:+611300851056) or [+64 9 259 4062](tel:+6492594062)  
(Our distributor in Australia and New Zealand)

### Australian Distributor

AMSL Diabetes  
2 McCabe Place Chatswood  
NSW 2067  
AUSTRALIA

### New Zealand Distributor

NZMS Diabetes  
2A Fisher Crescent, Mt Wellington  
Auckland 1060  
NEW ZEALAND

### Australian Sponsor

Emergo Australia  
201 Sussex Street  
Darling Park, Tower II, Level 20  
Sydney NSW 2000  
AUSTRALIA

### New Zealand Sponsor

Clinical & Regulatory Services Limited  
P O Box 766  
Hastings  
NEW ZEALAND

 Glooko Inc  
579 University Avenue  
Palo Alto, CA 94301  
USA